



JHW14M-621
1/2" Drive Deep Impact Socket 6-Point 21 mm, Black Industrial Finish





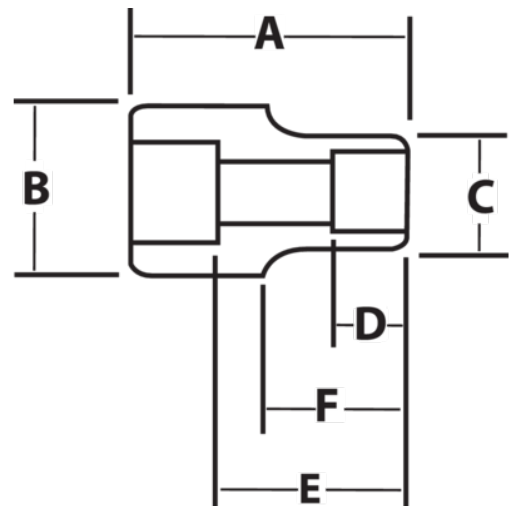

PRODUCT DETAILS

- SUPERTORQUE™ lobular openings for greater turning power without deforming the fastener
- Designed for maximum engagement on 6 point fasteners
- Suitable for use with pneumatic and electric impact wrenches
- Specially heat treated for impact use to provide long life, safety, and durability



PRODUCT ATTRIBUTES

Product			A	B	C	D	E		F	
JHW14M-621	1/2 in	21 mm	3-1/4 in	1-1/4 in	1-1/4 in	35/64 in	1-61/64 in	3/4 in	35/64 in	0.72 lb