



JHWHD-628
3/4 Drive Deep Socket, High Polished Chrome Finish, 6 Point, 7/8



PRODUCT DETAILS

- SUPERTORQUE® lobular openings for greater turning power without deforming the fastener
- Designed for maximum engagement on 6 point fasteners

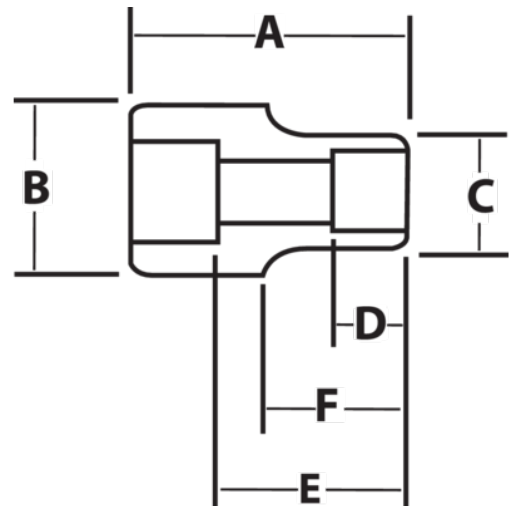

PRODUCT ATTRIBUTES

Product			A	B	C	D	E		F	
JHWHD-628	3/4 in	7/8 in	3-1/2 in	1-7/16 in	1-5/16 in	5/8 in	2-1/2 in	11/16 in	2-5/16 in	0.82 lb