



JHW38216
3/4" Drive Impact Hex Socket 1/2",
Black Industrial Finish





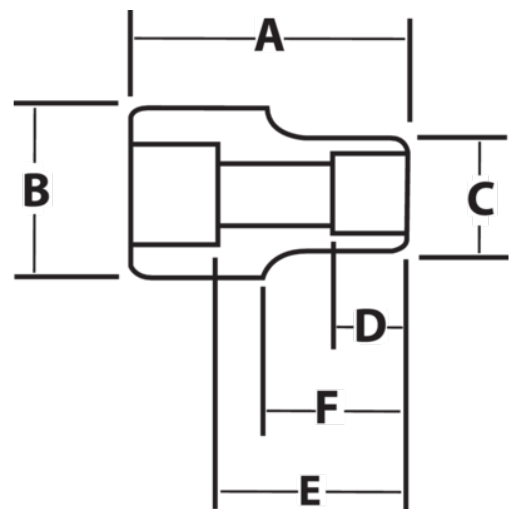

PRODUCT DETAILS

- One-piece design maximizes strength and reduces breakage
- Chamfered ends provide easy engagement of the drive tool and fastener
- Suitable for use with pneumatic and electric impact wrenches
- Specially heat treated for impact use to provide long life, safety, and durability
- Drive end features pin retention hole and groove



PRODUCT ATTRIBUTES

Product			A	B	C	D	E		F	
JHW38216	3/4 in	1/2 in	3-1/2 in	1-3/4 in	3/4 in	6-1XS in	6-1A/6-2C in			1.01 lb