



JHW6-660

**3/4" Drive Shallow Impact Socket
6-Point 1-7/8", Black Industrial
Finish**





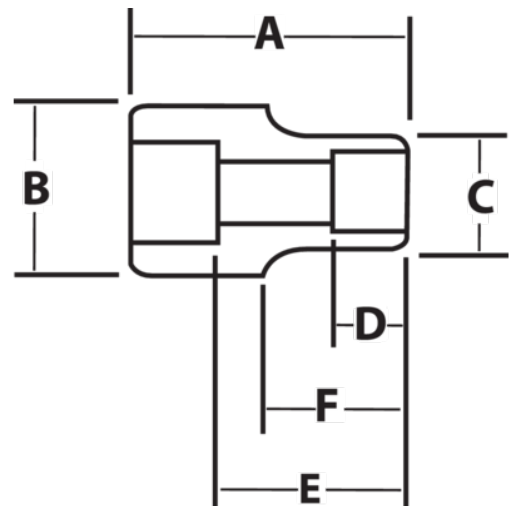

PRODUCT DETAILS

- SUPERTORQUE™ lobular openings for greater turning power without deforming the fastener
- Designed for maximum engagement on 6 point fasteners
- Suitable for use with pneumatic and electric impact wrenches
- Specially heat treated for impact use to provide long life, safety, and durability



PRODUCT ATTRIBUTES

Product			A	B	C	D	E		F	
JHW6-660	3/4 in	1-7/8 in	2-3/4 in	1-3/4 in	2-5/8 in	1-1/8 in	1-13/16 in	1-7/16 in	2-1/16 in	1.85 lb