



**JHW6-676**

**3/4" Drive Shallow Impact Socket  
6-Point 2-3/8", Black Industrial  
Finish**





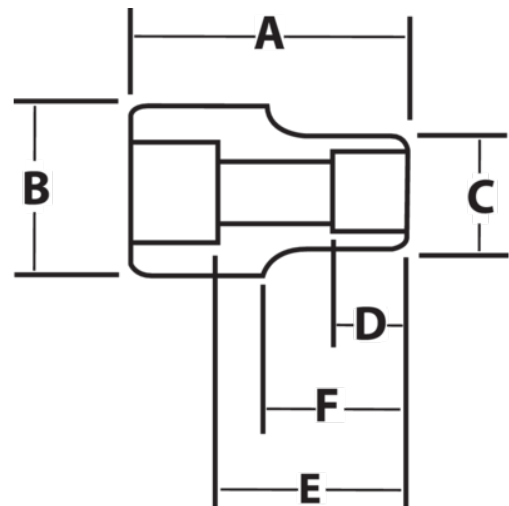

## PRODUCT DETAILS

- SUPERTORQUE™ lobular openings for greater turning power without deforming the fastener
- Designed for maximum engagement on 6 point fasteners
- Suitable for use with pneumatic and electric impact wrenches
- Specially heat treated for impact use to provide long life, safety, and durability



PRODUCT ATTRIBUTES

Product			<b>A</b>	<b>B</b>	<b>C</b>	<b>D</b>	<b>E</b>		<b>F</b>	
<b>JHW6-676</b>	3/4 in	2-3/8 in	3-1/2 in	1-3/4 in	3-1/4 in	1-7/16 in	2-7/16 in	1-27/32 in	2-13/16 in	3.2 lb