



JHW6M-1221
3/4 Drive Shallow Impact Sockets,
12 Point 21 mm , Black Industrial
Finish





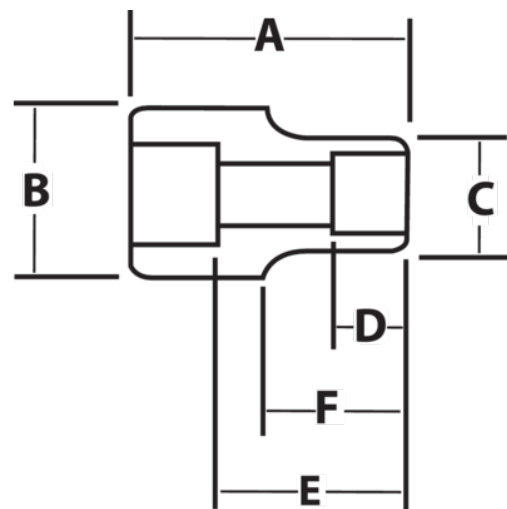

PRODUCT DETAILS

- SUPERTORQUE® lobular openings for greater turning power without deforming the fastener
- Designed for maximum engagement on 6 and 12 point fasteners
- Suitable for use with pneumatic and electric impact wrenches
- Specially heat treated for impact use to provide long life, safety, and durability
- Drive end features pin retention hole and groove



PRODUCT ATTRIBUTES

Product			A	B	C	D	E		F	
JHW6M-1221	3/4 in	21-mm	2 in	1-5/8 in	1-3/8 in	1/2 in	1 in	2/3 in	1 in	0.68 lb