



JHW6M-634

**3/4" Drive Shallow Impact Socket
6-Point 34M, Black Industrial
Finish**





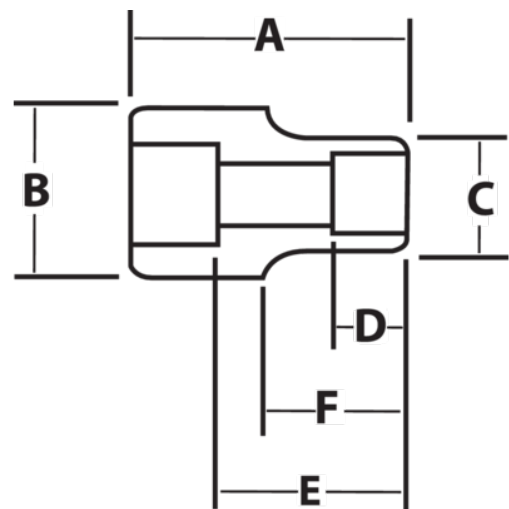

PRODUCT DETAILS

- SUPERTORQUE® lobular openings for greater turning power without deforming the fastener
- Designed for maximum engagement on 6 point fasteners
- Suitable for use with pneumatic and electric impact wrenches
- Specially heat treated for impact use to provide long life, safety, and durability
- Drive end features pin retention hole and groove



PRODUCT ATTRIBUTES

Product			A	B	C	D	E		F	
JHW6M-634	3/4 in	34-mm	2-1/8 in	1-3/4 in	2 in	7/8 in	1-3/16 in	1-21/64 in	1-7/16 in	0.99 lb