



JHWX-1276
12 Drive Shallow 12-Point Socket,
High Polished Chrome Finish,
2-1/4



PRODUCT DETAILS

- SUPERTORQUE® lobular openings for greater turning power without deforming the fastener
- Designed for quick engagement on both 6 and 12 point fasteners

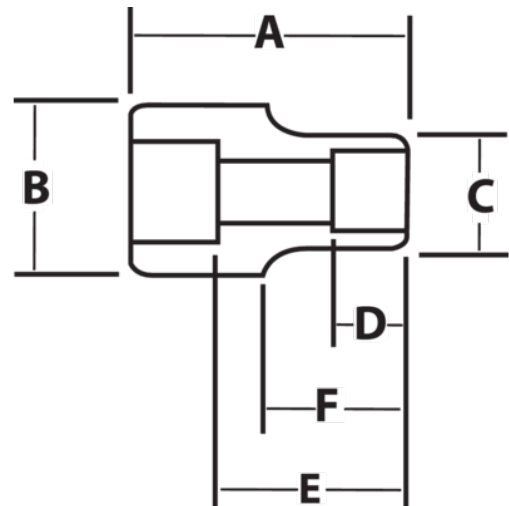

PRODUCT ATTRIBUTES

Product			A	B	C	D	E		F	
JHWX-1276	1 in	2-3/8 in	3-7/8 in	2-1/4 in	3-3/8 in	1-5/8 in	2-3/4 in	2-3/8 in	2-13/16 in	4.03 lb