



JHW17-6104
1" Drive Deep Impact Socket 6-Point 3-1/4", Black Industrial Finish





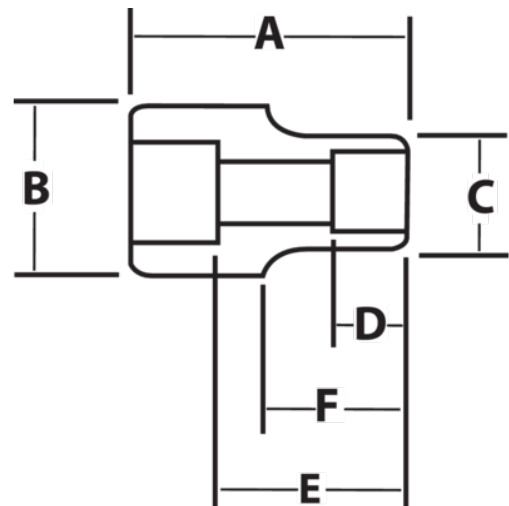

PRODUCT DETAILS

- SUPERTORQUE® lobular openings for greater turning power without deforming the fastener
- Designed for maximum engagement on 6 point fasteners
- Suitable for use with pneumatic and electric impact wrenches
- Specially heat treated for impact use to provide long life, safety, and durability



PRODUCT ATTRIBUTES

Product			A	B	C	D	E		F	
JHW17-6104	1 in	3-1/4 in	5-3/8 in	2-3/8 in	4-1/2 in	2-1/32 in	3-1/32 in	2-3/8 in	2-1/32 in	11.36 lb