



JHW17-6138
1" Drive Deep Impact Socket 6-Point 4-5/16", Black Industrial Finish





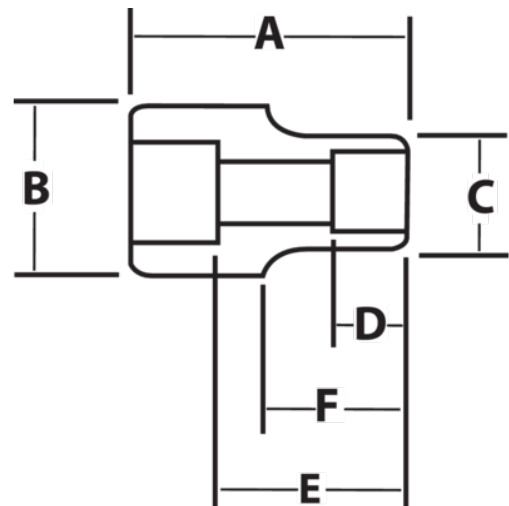

PRODUCT DETAILS

- SUPERTORQUE® lobular openings for greater turning power without deforming the fastener
- Designed for maximum engagement on 6 point fasteners
- Suitable for use with pneumatic and electric impact wrenches
- Specially heat treated for impact use to provide long life, safety, and durability



PRODUCT ATTRIBUTES

Product			A	B	C	D	E		F	
JHW17-6138	1 in	4-5/16 in	6-11/32 in	2-3/8 in	5-13/16 in	2-21/32 in	4-5/8 in	3-3/8 in	2-21/32 in	25.31 lb