



JHW7-1256

**1 Drive Shallow 12 Point 1 3/4
Impact Socket, Black Industrial
Finish**





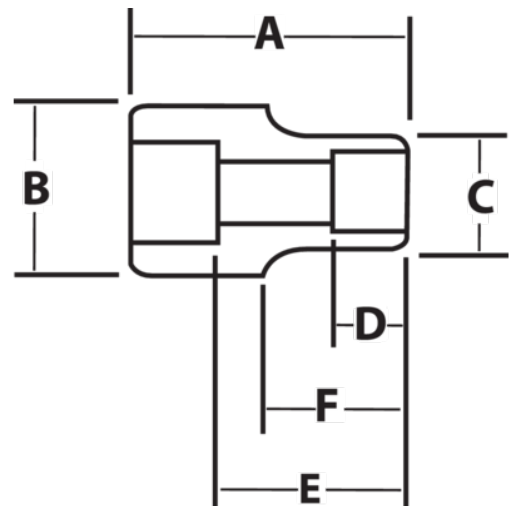

PRODUCT DETAILS

- SUPERTORQUE® lobular openings for greater turning power without deforming the fastener
- Designed for maximum engagement on 6 and 12 point fasteners
- Suitable for use with pneumatic and electric impact wrenches
- Specially heat treated for impact use to provide long life, safety, and durability



PRODUCT ATTRIBUTES

Product			A	B	C	D	E		F	
JHW7-1256	1 in	1-3/4 in	3 in	2-1/4 in	2-5/8 in	1-1/4 in	1-7/8 in	1-7/16 in		2.44 lb