



JHW7-1274

**1 Drive Shallow 12 Point 2 5/16"
Impact Socket, Black Industrial
Finish**





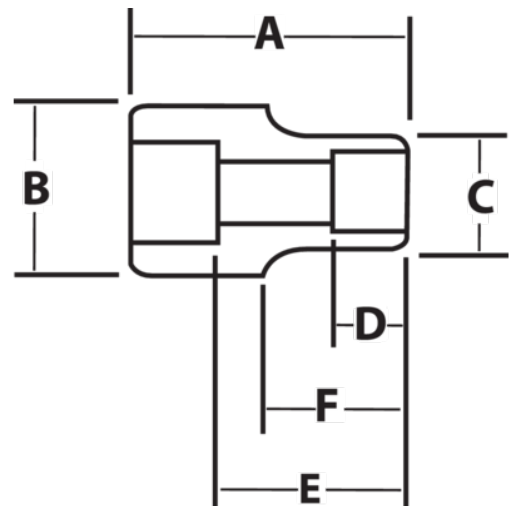

PRODUCT DETAILS

- SUPERTORQUE® lobular openings for greater turning power without deforming the fastener
- Designed for maximum engagement on 6 and 12 point fasteners
- Suitable for use with pneumatic and electric impact wrenches
- Specially heat treated for impact use to provide long life, safety, and durability



PRODUCT ATTRIBUTES

Product			A	B	C	D	E		F	
JHW7-1274	1 in	2-5/16 in	3-3/4 in	2-3/8 in	3-1/4 in	1-1/2 in	2-3/8 in	2-1/4 in		4.15 lb