



**JHW7-1276**

**1 Drive Shallow 12 Point 2 3/8  
Impact Socket, Black Industrial  
Finish**





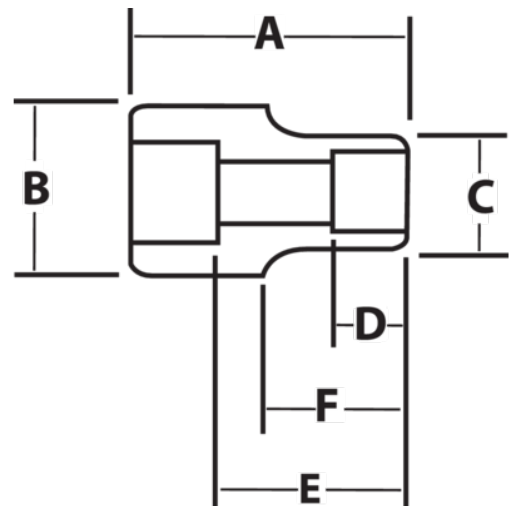

## PRODUCT DETAILS

- SUPERTORQUE® lobular openings for greater turning power without deforming the fastener
- Designed for maximum engagement on 6 and 12 point fasteners
- Suitable for use with pneumatic and electric impact wrenches
- Specially heat treated for impact use to provide long life, safety, and durability



PRODUCT ATTRIBUTES

Product			<b>A</b>	<b>B</b>	<b>C</b>	<b>D</b>	<b>E</b>		<b>F</b>	
<b>JHW7-1276</b>	1 in	2-3/8 in	3-3/4 in	2-3/8 in	3-3/8 in	1-1/2 in	2-3/8 in	2-1/3 in		4.3 lb