



JHW7-1284
1 Drive Shallow 12 Point 2 5/8"
Impact Socket, Black Industrial
Finish





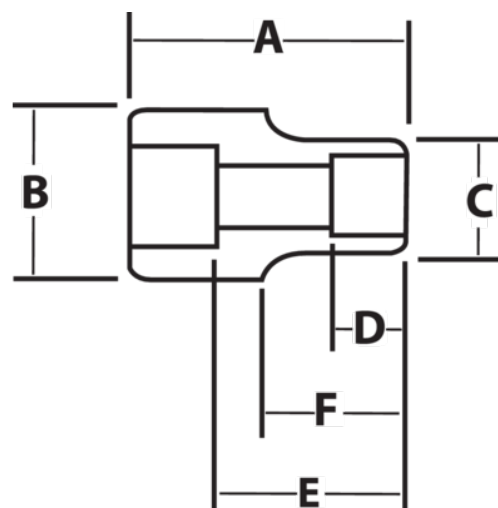

PRODUCT DETAILS

- SUPERTORQUE® lobular openings for greater turning power without deforming the fastener
- Designed for maximum engagement on 6 and 12 point fasteners
- Suitable for use with pneumatic and electric impact wrenches
- Specially heat treated for impact use to provide long life, safety, and durability



PRODUCT ATTRIBUTES

Product			A	B	C	D	E		F	
JHW7-1284	1 in	2-5/8 in	4 in	2-3/8 in	3-5/8 in	1-1/2 in	2-1/2 in	2-1/2 in		5.22 lb