



JHW41146
1-1/2 Drive 1-7/16 Shallow Impact
Socket 12 Point , Black Industrial
Finish





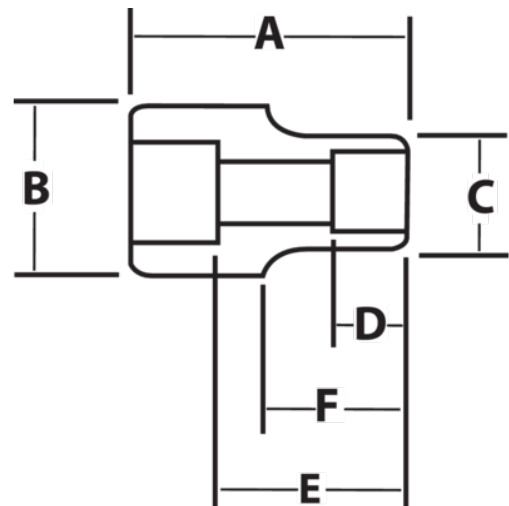

PRODUCT DETAILS

- SUPERTORQUE® lobular openings for greater turning power without deforming the fastener
- Designed for maximum engagement on 6 and 12 point fasteners
- Suitable for use with pneumatic and electric impact wrenches
- Specially heat treated for impact use to provide long life, safety, and durability



PRODUCT ATTRIBUTES

Product			A	B	C	D	E		F	
JHW41146	1-1/2 in	1-7/16 in	3-1/8 in	3-3/8 in	2-1/2 in	1 in		1-1/4 in	1-3/8 in	4.6 lb