



JHW41188
1-1/2 Drive 2-3/4 Shallow Impact
Socket 12 Point , Black Industrial
Finish





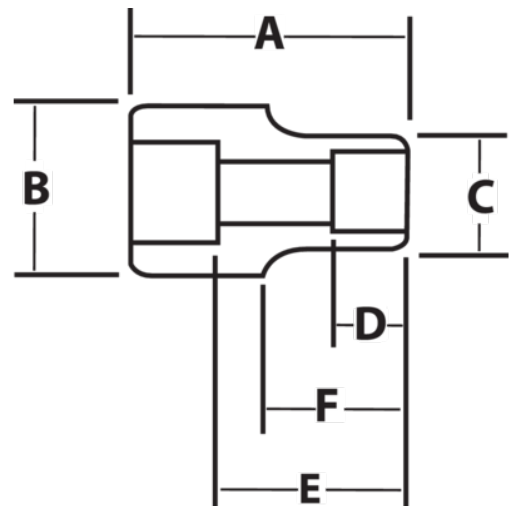

PRODUCT DETAILS

- SUPERTORQUE® lobular openings for greater turning power without deforming the fastener
- Designed for maximum engagement on 6 and 12 point fasteners
- Suitable for use with pneumatic and electric impact wrenches
- Specially heat treated for impact use to provide long life, safety, and durability



PRODUCT ATTRIBUTES

Product			A	B	C	D	E		F	
JHW41188	1-1/2 in	2-3/4 in	3-3/4 in	3-3/8 in	4-3/16 in	1-5/8 in		2-1/2 in	1-3/4 in	7.15 lb