



JHW8-6124
1-1/2 Drive Shallow Impact Socket,
6 Point, 3-7/8, Black Industrial
Finish





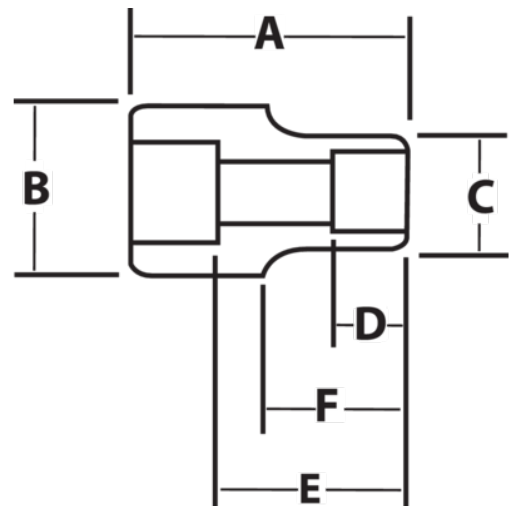

PRODUCT DETAILS

- SUPERTORQUE™ lobular openings for greater turning power without deforming the fastener
- Designed for maximum engagement on 6 point fasteners
- Suitable for use with pneumatic and electric impact wrenches
- Specially heat treated for impact use to provide long life, safety, and durability



PRODUCT ATTRIBUTES

Product			A	B	C	D	E		F	
JHW8-6124	1-1/2 in	3-7/8 in	5-1/4 in	3-1/4 in	5-17/32 in	2-9/16 in	3-5/8 in	2-5/8 in	3-5/32 in	14.33 lb