



JHW8-678
1-1/2 Drive Shallow Impact Socket,
6 Point, 2-7/16, Black Industrial
Finish





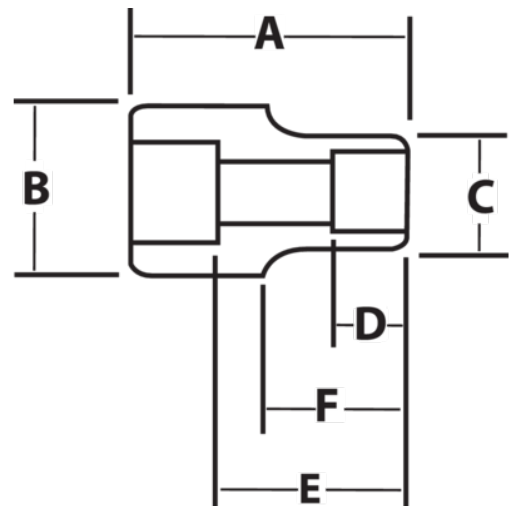

PRODUCT DETAILS

- SUPERTORQUE™ lobular openings for greater turning power without deforming the fastener
- Designed for maximum engagement on 6 point fasteners
- Suitable for use with pneumatic and electric impact wrenches
- Specially heat treated for impact use to provide long life, safety, and durability



PRODUCT ATTRIBUTES

Product			A	B	C	D	E		F	
JHW8-678	1-1/2 in	2-7/16 in	3-15/16 in	3-1/4 in	3-25/32 in	1-9/16 in	2-19/64 in	2-7/16 in	2-5/16 in	6.58 lb