



JHW6CN55T06
55T Locking Nut Cylinder 6" Stroke







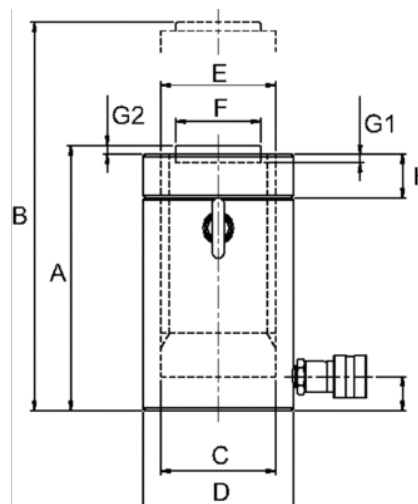

PRODUCT DETAILS

- Single acting cylinder with mechanical safety lock nut
- Designed to support load for extended periods without hydraulic pressure
- Overflow port prevents cylinders from over travel
- Load return
- Solid steel cylinder body
- Ideal for lifting and holding loads



PRODUCT ATTRIBUTES

Product: **JHW6CN55T06**

	55 t		5.91 in		10.99 in
	64.9 in ³	A	10.4 in	B	16.3 in
C	3.7 in	D	4.9 in	F	2.8 in
	55.1 lb		Tw95-6N	G1	0.08 in
G2	0.51 in	H	1.4 in	I	1.1 in