



**JHW6CN100T02**  
**100T Locking Nut Cylinder 2"**  
**Stoke**







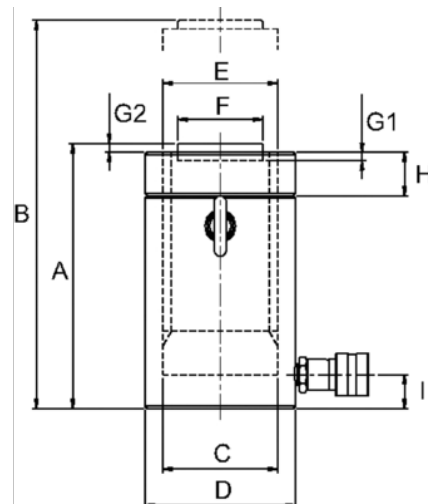

**PRODUCT DETAILS**

- Single acting cylinder with mechanical safety lock nut
- Designed to support load for extended periods without hydraulic pressure
- Overflow port prevents cylinders from over travel
- Load return
- Solid steel cylinder body
- Ideal for lifting and holding loads



PRODUCT ATTRIBUTES

Product: **JHW6CN100T02**

	100 t		1.97 in		20.57 in
	40.49 in <sup>3</sup>	<b>A</b>	7.4 in	<b>B</b>	9.3 in
<b>C</b>	5.1 in	<b>D</b>	6.5 in	<b>F</b>	2.8 in
	67.2 lb		Tw130-4N	<b>G1</b>	0.08 in
<b>G2</b>	0.51 in	<b>H</b>	1.8 in	<b>I</b>	1.1 in