



JHW6CN100T08
100T Locking Nut Cylinder 8"
Stoke







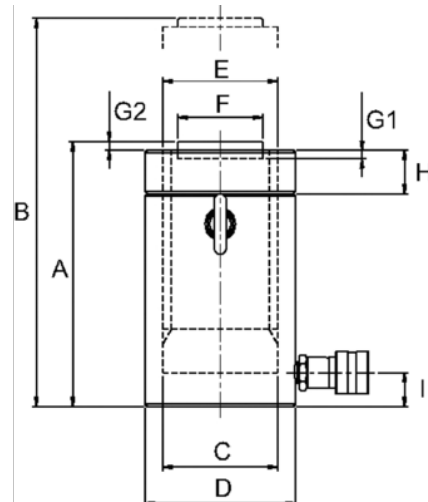

PRODUCT DETAILS

- Single acting cylinder with mechanical safety lock nut
- Designed to support load for extended periods without hydraulic pressure
- Overflow port prevents cylinders from over travel
- Load return
- Solid steel cylinder body
- Ideal for lifting and holding loads



PRODUCT ATTRIBUTES

Product: **JHW6CN100T08**

	100 t		7.87 in		20.57 in
	161.97 in ³	A	13.3 in	B	21.1 in
C	5.1 in	D	6.5 in	F	2.8 in
	122.6 lb		Tw130-4N	G1	0.08 in
G2	0.51 in	H	1.8 in	I	1.1 in