



JHW6CN100T12
100T Locking Nut Cylinder 12"
Stoke







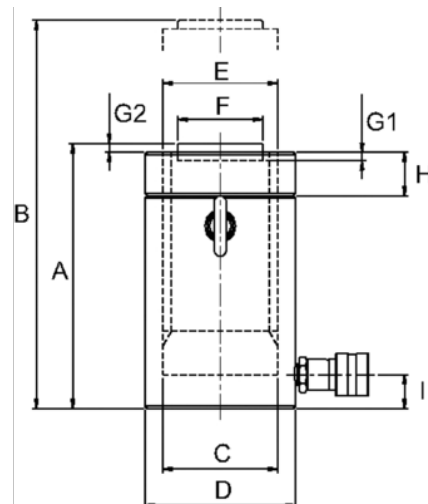

PRODUCT DETAILS

- Single acting cylinder with mechanical safety lock nut
- Designed to support load for extended periods without hydraulic pressure
- Overflow port prevents cylinders from over travel
- Load return
- Solid steel cylinder body
- Ideal for lifting and holding loads



PRODUCT ATTRIBUTES

Product: **JHW6CN100T12**

	100 t		11.81 in		20.57 in
	242.95 in ³	A	17.2 in	B	29 in
C	5.1 in	D	6.5 in	F	2.8 in
	159.6 lb		Tw130-4N	G1	0.08 in
G2	0.51 in	H	1.8 in	I	1.1 in