



**QCB-300**  
**Quick Clamps with 200 kg Force**  
**300 mm**



**PRODUCT DETAILS**

- QCB clamp has a force of 200 kg
- A wider range up to 1250 mm in length
- Can also be used as a spreader
- Variable speed trigger mechanism increases power as the head makes contact with the work piece
- Variable speed mechanism makes it easier to reach high clamping force
- Removable pads with V-groove
- Easy to adapt to a spreader with the spreader button
- Easy-access release mechanism
- Comfortable handle for use at any angle; upside down, front to back

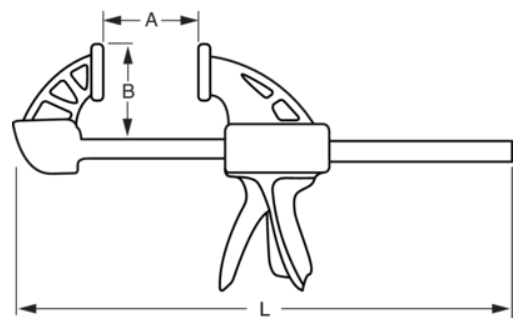

PRODUCT ATTRIBUTES

Product		<b>A</b>	<b>B</b>	
<b>QCB-300</b>	606 mm	300 mm	95 mm	1044 g