



QCB-600
Quick Clamps with 200 kg Force
600 mm



PRODUCT DETAILS

- QCB clamp has a force of 200 kg
- A wider range up to 1250 mm in length
- Can also be used as a spreader
- Variable speed trigger mechanism increases power as the head makes contact with the work piece
- Variable speed mechanism makes it easier to reach high clamping force
- Removable pads with V-groove
- Easy to adapt to a spreader with the spreader button
- Easy-access release mechanism
- Comfortable handle for use at any angle; upside down, front to back

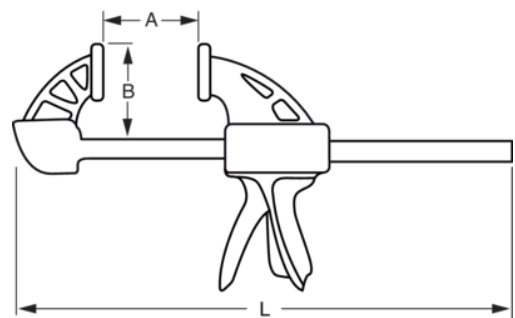

PRODUCT ATTRIBUTES

Product		A	B	
QCB-600	906 mm	600 mm	95 mm	1320 g