



**JHW38426**  
**3/4 Drive 13/16 Shallow Impact**  
**Socket 12 Point, Black Industrial**  
**Finish**





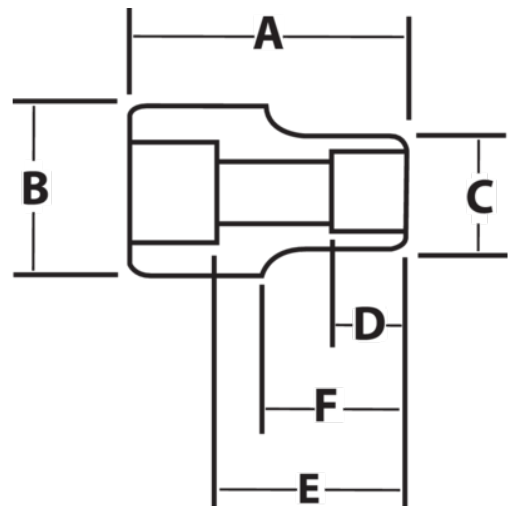

**PRODUCT DETAILS**

- SUPERTORQUE® lobular openings for greater turning power without deforming the fastener
- Designed for maximum engagement on 6 or 12 point fasteners
- Suitable for use with pneumatic and electric impact wrenches
- Specially heat treated for impact use to provide long life, safety, and durability



PRODUCT ATTRIBUTES

Product			<b>A</b>	<b>B</b>	<b>C</b>	<b>D</b>	<b>E</b>		<b>F</b>	
<b>JHW38426</b>	3/4 in	13/16 in	2-1/16 in	1-1/2 in	1-1/4 in	3/4 in		3/4 in	15/16 in	0.58 lb